

**Sam Shui Natives Association Huen King Wing School**  
**2019-20 2<sup>nd</sup> Term**  
**Primary 1 English Revision Paper 2.1**

Name : \_\_\_\_\_

Class: P. 1 ( )

Date: \_\_\_\_\_

Jenny is reading some notices in the children's centre. Read the notices and blacken the correct answer.

## Notices

### Lost! My toy cat Puss

It is thin.

It has long legs.

It has short hair.

Call Rick (2255 6677). Thank you!

### Lost! My pencil case

It is big. There are two rabbits on it.

It has three pens.

It has two erasers.

It has five rulers.

Please call Lily (2333 4444).

### Lost! My toy hamsters

They are Jo and Bo.

They are small.

They have short and thin tails.

They have small ears.

They have big mouths.

Please telephone 2222 6565 (Amy).

1 Which one is Puss?

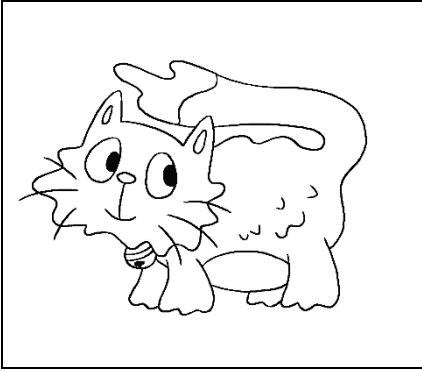

A.

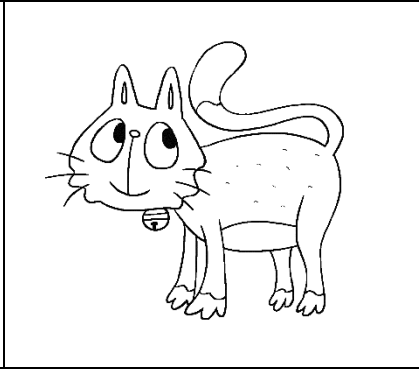

B.

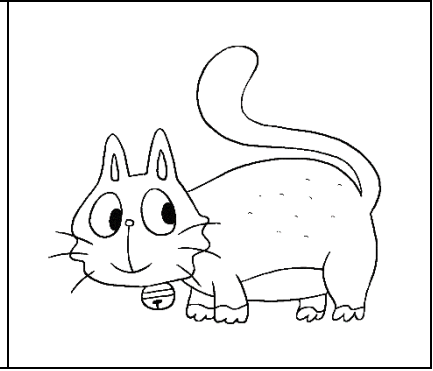

C.

2 Which is Lily's pencil case?

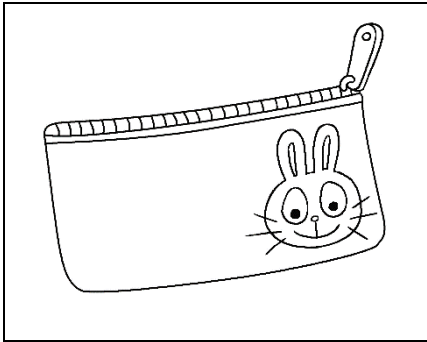

A.

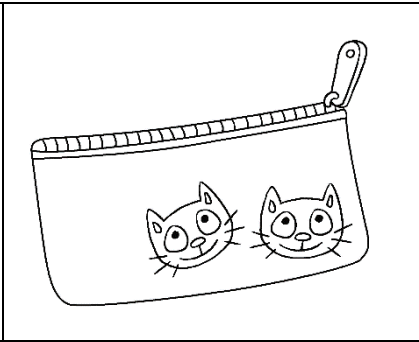

B.

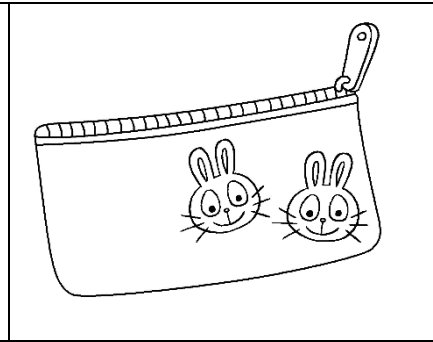

C.

3 Lily has \_\_\_\_ .

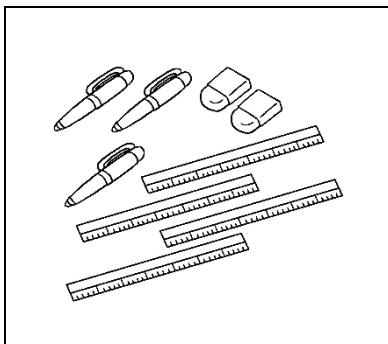

A.

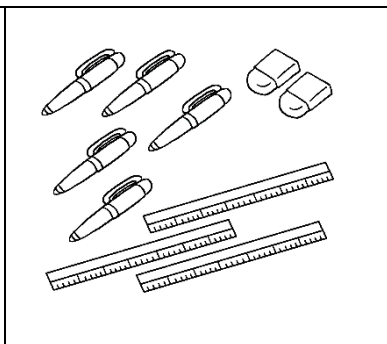

B.

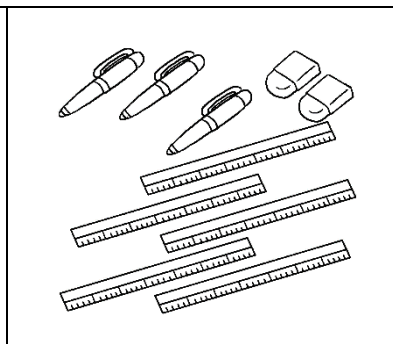

C.

4 Which one is Jo?

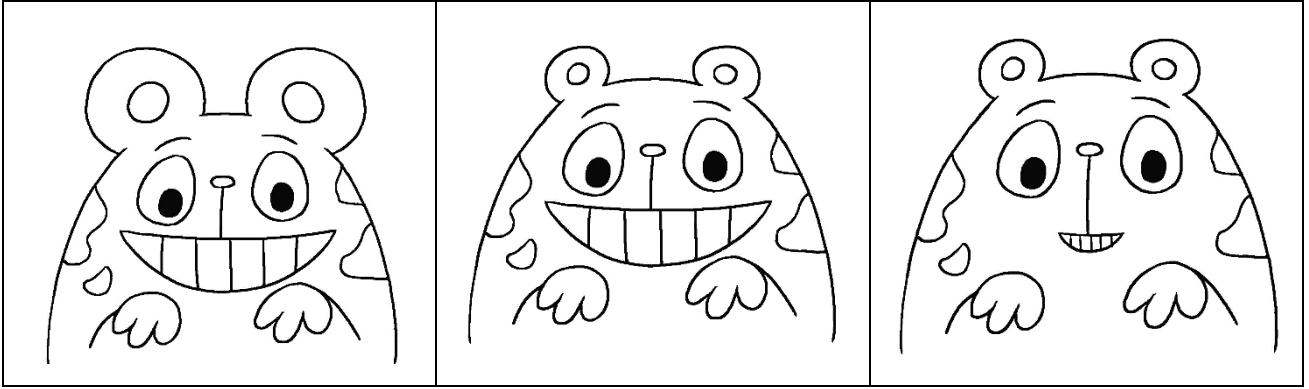

A.

B.

C.

5 \_\_\_\_\_ has two toy animals.

- A. Rick
- B. Lily
- C. Amy

6 Jenny sees the toy cat. She can call \_\_\_\_\_ .

- A. 2255 6677
- B. 2333 4444
- C. 2222 6565



Study hard !

**Sam Shui Natives Association Huen King Wing School**  
**2019-20 2<sup>nd</sup> Term**  
**Primary 1 English Revision Paper 2.2**

Name : \_\_\_\_\_

Class: P. 1 ( )

Date: \_\_\_\_\_

What are the children saying? Fill in the blanks with correct words.

is	am	are
----	----	-----

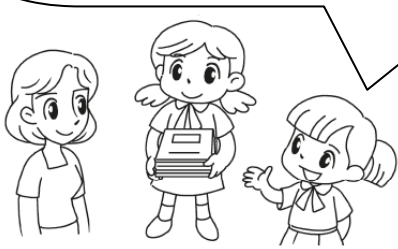
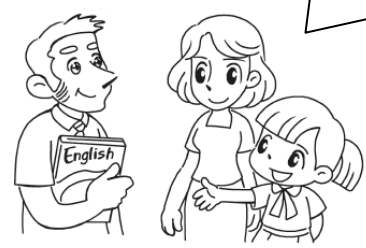
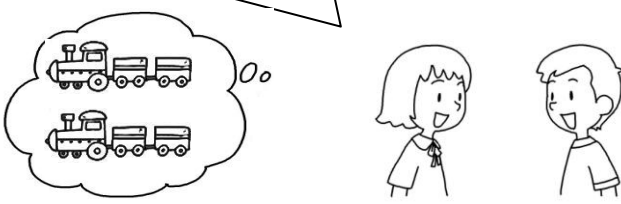
<p><b>1</b></p> <p>This is Lucy. She <u>e.g. is</u> my friend.</p> 	<p><b>2</b></p> <p>Hi. My name is Michael. I _____ six years old.</p> 
<p><b>3</b></p> <p>This is Mr Bell. He _____ my teacher.</p> 	<p><b>4</b></p> <p>I have a plane. It _____ white.</p> 
<p><b>5</b></p> <p>I have two trains. They _____ red.</p> 	<p><b>6</b></p> <p>This is Macy. We _____ good friends.</p> 

**Sam Shui Natives Association Huen King Wing School**  
**2019-20 2<sup>nd</sup> Term**  
**Primary 1 English Revision Paper 2.3**

Name : \_\_\_\_\_

Class: P. 1 ( )

Date: \_\_\_\_\_

A. Some children are talking. Fill in the blanks with correct words.

this	that	these	those
------	------	-------	-------

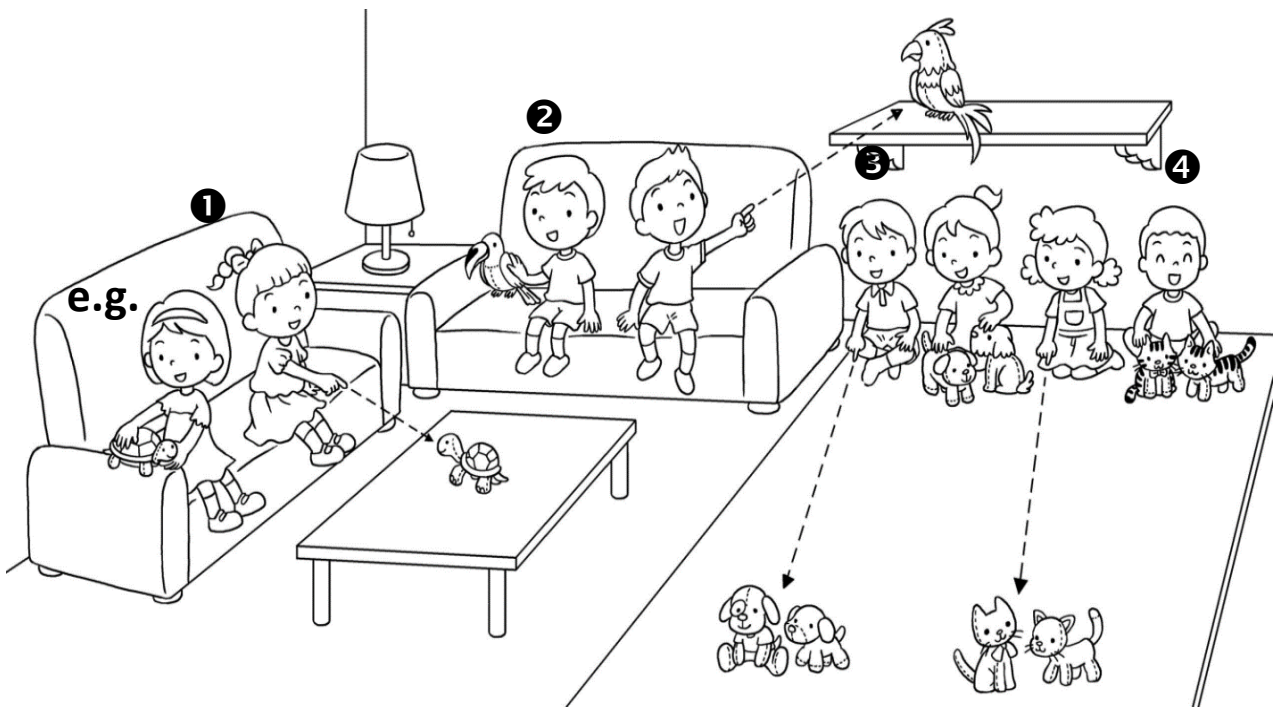

e.g. I like     this     turtle.

1 I like \_\_\_\_\_ turtle.

2 I like \_\_\_\_\_ bird.

3 I like \_\_\_\_\_ dogs.

4 I like \_\_\_\_\_ cats.

**B. Rearrange the words to form correct sentences.**

e.g. big / is / The / dog / very / . /

**The dog is very big.**

---

1. This / my / is / . / pencil case /

---

2. under / are / These / . / apples / the / table /

---



Study hard !